



JOY

Artwork inspired by the City of Joliet, Illinois



INTRODUCTION

It is with great excitement that I present **'JOY'**, a larger-than-life sculpture experience created for the City of Joliet.

With a form inspired by the rebirth of this area into a public gathering place, **'JOY'** is a piece that uplifts and commemorates community. The sculpture is designed to evoke the spirit of unity, wonder and progress, while celebrating Joliet's diversity. It serves as an exuberant testament to the many cultures converging here to create the colorful cultural mosaic that is the community of Joliet.

Warmly enveloped within a communal space like the city square, **'JOY'** invites the community in - providing a place for connection and inspiration.

DESIGN

When reviewing the site plans, I saw an opportunity for the artwork to experiential in nature. The inherent red carpet path naturally lends itself to the creation of this portal, leading visitors into an experience. The artwork becomes more than just an object but also a journey and destination.

Perforated stainless steel panels with colorful coatings create a robust base, evolving into more translucent colored Koda XT polycarbonate panels towards the top.

Integrated lighting allows the piece to glow from within - reminiscent of the sparkle of fireflies and the glow of neighboring entertainment venues like the historic Rialto Theater and Forge Music Hall.

RENDERING





COLLABORATION

To finalize the design, we envision a collaborative process. There are many concerns to embrace in this process - ensuring proper clearances for pedestrians, eliminating the opportunities to climb the work, mitigating extensive maintenance needs, enhancing community experience, and refining the aesthetics in conjunction with structural engineering.

We welcome all of these considerations with open arms and enjoy integrating these as part of the design process. Our commitment is always to produce a magical artwork that aligns with the goals of the community and stakeholders alike. We often institute a community engagement process and/or engage in a robust dialogue with the stakeholders to create the best sculpture possible for the project.

ARCH MODULES

The sculpture will consist of five arches, each varying in scale, converging to form the complete artwork.

This approach introduces a dynamic interplay of space and depth. It also allows for flexibility during the development phase to refine and iterate the design.

Our aim is to maximize both the visual and experiential impact by blending artistic vision with thoughtful engineering.

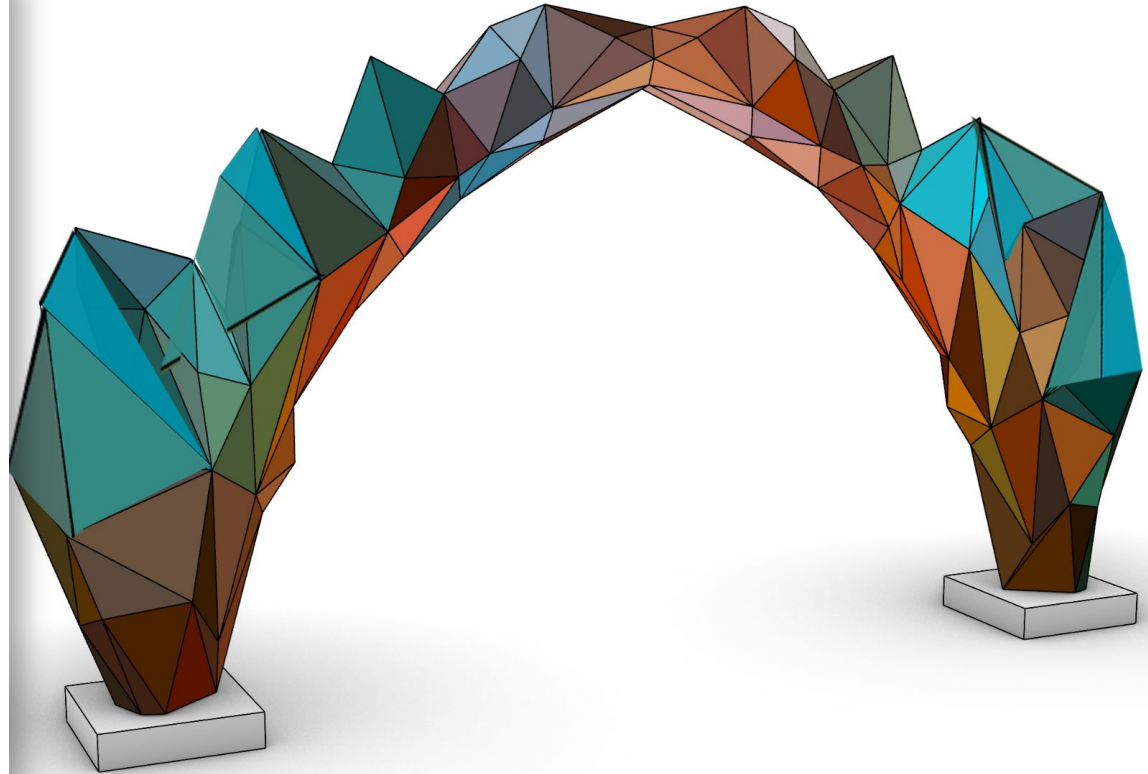

DIMENSIONS

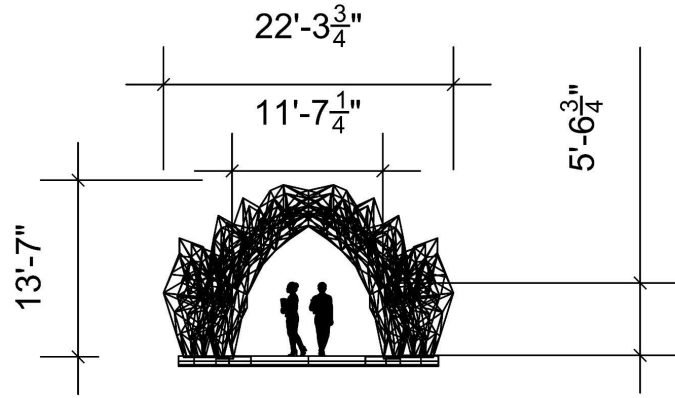

FRONT VIEW

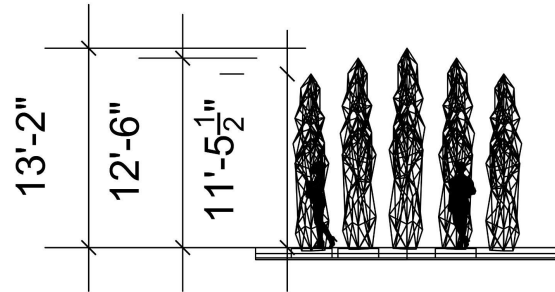

SIDE VIEW

TOP VIEW

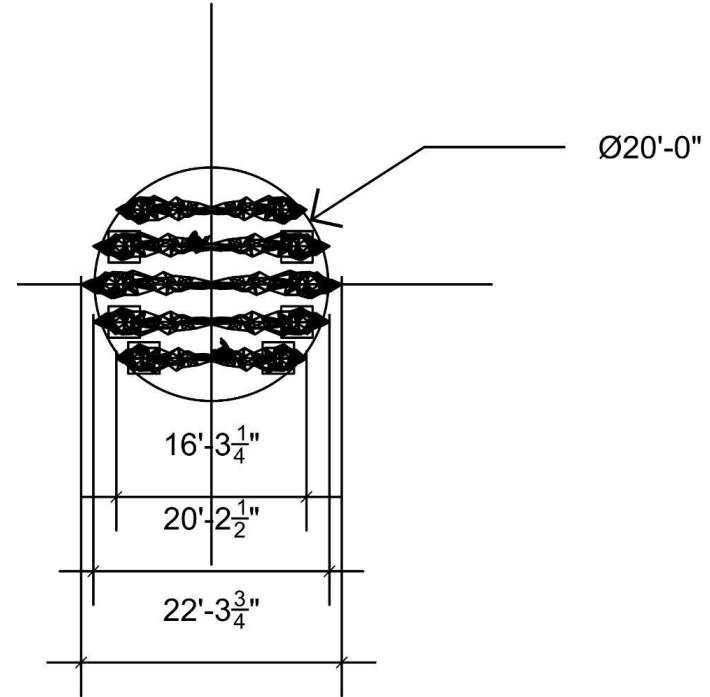

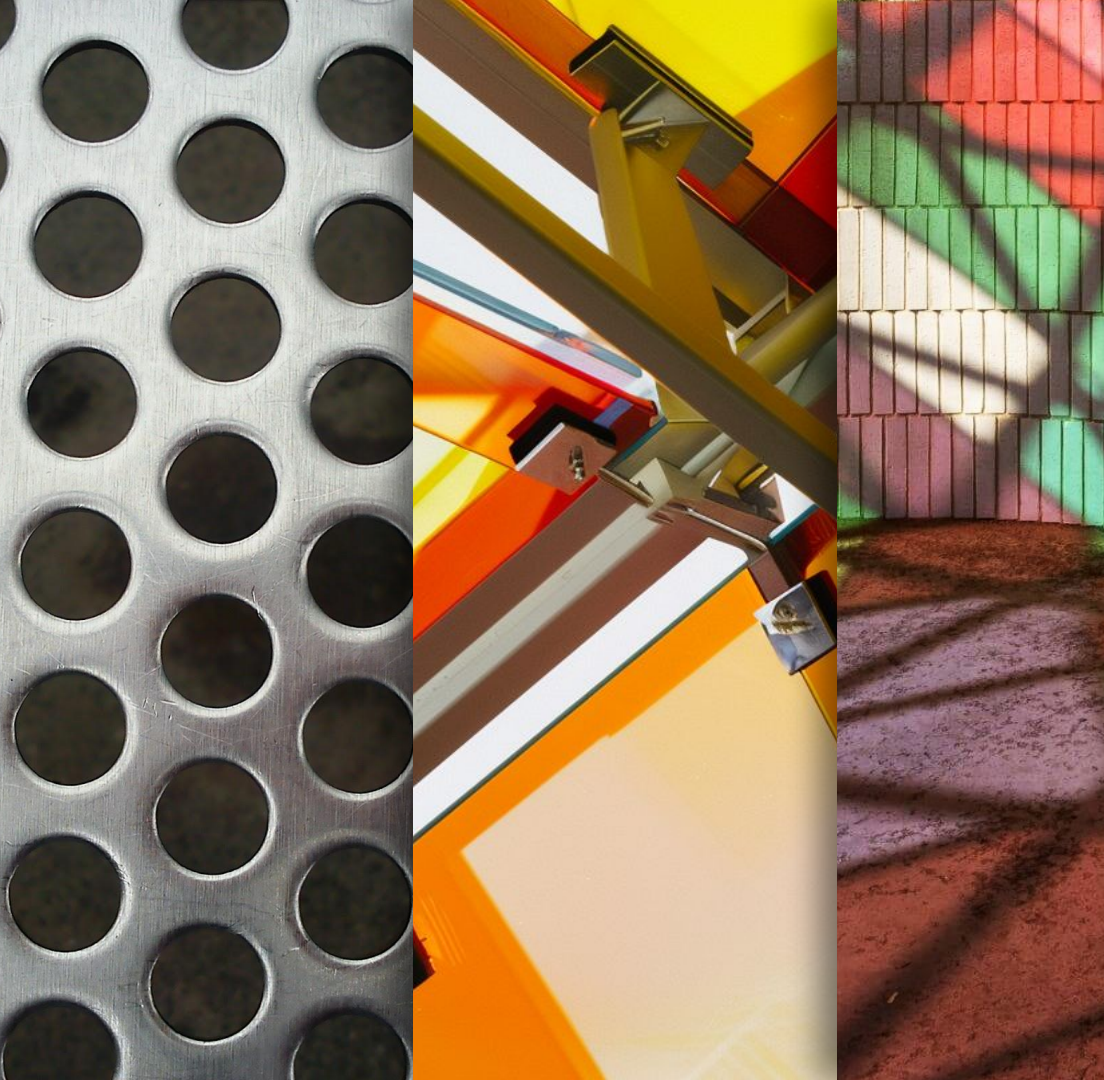

PLANNED MATERIALS

We utilize LEED certified green materials and develop processes to reduce and reuse waste materials wherever possible. These materials are durable and can withstand harsh weather conditions like extreme desert sun, hurricane winds, and snowstorms.

Primary Materials:

Laser-cut aluminum, stainless steel, KODA XT colored polycarbonate, powder coated aluminum, stainless steel and protective coating and films.

Anchoring System:

Concrete foundation with epoxy embedded steel anchors.

Additional Materials:

Protective barriers during installation, LED lighting and control system, and landscaping materials for site integration.

ABOUT KODA XT

KODA XT is a virtually unbreakable, LEED-certified exterior material by 3Form that offers exceptional durability and color options. Its impact resistance surpasses acrylic by 60 times and glass by 100, unmatched in the glazing market.



NOPALES // BEVERLY HILLS, CA





POWER & LIGHTING

The lighting system will be designed for versatility, allowing for different programming requirements, such as warm, soft lighting to create an inviting ambiance for quiet nights, or more dynamic patterns to energize special events. The dancing rhythms of fireflies is one detail of the interior lighting plan we are considering to embrace to elevate the sense of wonder within the artwork.

It may be possible to make the lighting site-reactive, allowing the sculpture to respond to human activity in the space. This will be explored as the final design is developed and structural engineering analysis commences.

We anticipate power needs to be 2 circuits of 110 VAC @ 20 amps.



WORK PLAN

OUR TEAM

Having worked together on many large-scale artworks throughout the years, our team brings a streamlined approach to successfully take a project from design to installation.

We ensure that the project stays on schedule and budget, with specialists trained in welding, metalworking, fabrication, heavy equipment handling, and installation.



JAMES PETERSON
Artist/Principal



TITA PETERSON
Graphic Design/Media



STELLA CHO
Project Manager



MICHAEL SAENZ
Project Manager



**SELINDA MARTINEZ
+ ALI LAHIJANIAN**
Structural Engineers



ANDREA KROUT
Installation Lead &
Rigger



ALAN LUM
Structural Engineer



TODD MOYER
Lighting Designer

FABRICATION PROCESSES

To create these magical forms, parametric computer modeling is used to develop efficient processes that combine the metals, 3Form KODA XT and LED lighting. Each concept can be adjusted in terms of color and finishing, which can consist of powder coating or automotive-grade paint designed for long-lasting durability.

Metal tubes will be used as the primary backbone of each arch coupled with laser cut and CNC bent metal sheets for the faceted paneling. Components will be welded together to create structural connections that integrate with structural tubes. Elements are then welded and bolted together following detailed engineering plans that ensure stability and safety.

The structure is partially assembled in the workshop to ensure fit and finish, with all welds inspected for quality and strength. The sculpture then undergoes processes to clean the surface, followed by an application of protective coating to prevent corrosion.



INSTALLATION PLAN

Following a site survey, our team will create an installation plan that minimizes disruption to the city square, and includes engineering specifications for the concrete pad foundation provided by The City. Sculptural components will be transported to the site using flatbed trucks, with oversized loads escorted per local regulations.

A variable reach forklift and scissor lifts will be used to position and assemble components of the sculpture on-site. This work is supervised by our lead rigger and installation crew, who are specially trained in handling heavy equipment.

Careful coordination will take place to ensure the equipment is safe for the grounds capacity. The team ensures all components are transported safely on-site and securely anchors them to the foundation.

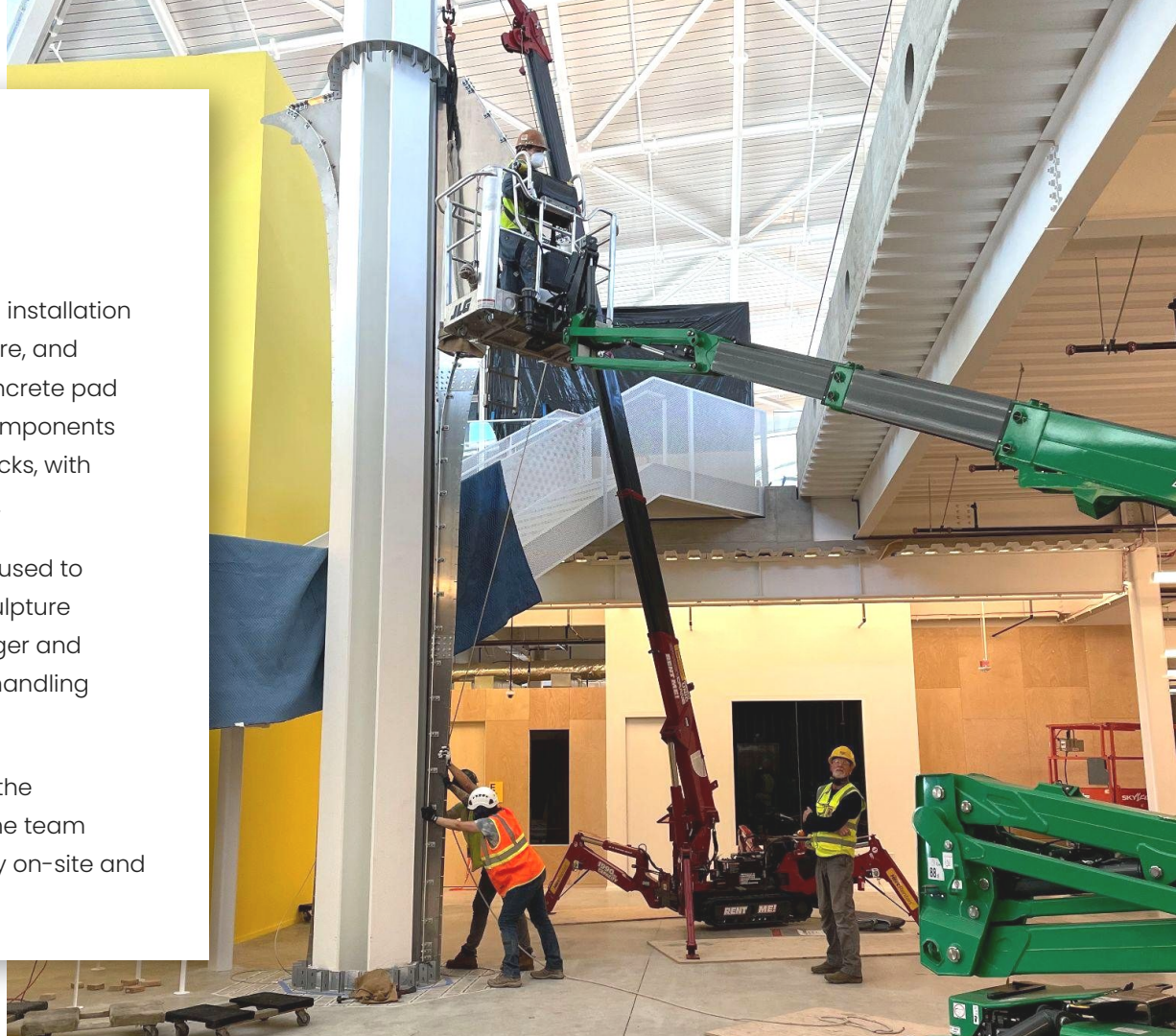



MAINTENANCE

The maintenance of the artwork will be straightforward, especially as the construction process will allow for the various panels to be removed for ease of servicing.

The sculpture should be inspected quarterly for structural integrity, signs of corrosion, and any damage. The surface is to be cleaned biannually to remove dirt, debris, and any graffiti. Non-abrasive cleaning methods will be used to preserve the finishes. Any minor damages or wear and tear should be addressed immediately. This includes reapplying protective coatings and/or replacing any damaged parts. The lighting, utilizing long-lasting LED technology with a lifespan of 20,000 hours, will require minimal upkeep.

Detailed records of all inspections, cleanings, and repairs should be maintained. This helps in tracking the sculpture's condition over time and planning long-term maintenance activities.

As with all my projects, I will provide digital files from the fabrication processes, along with comprehensive information and specifications for all components used in the artwork's creation.



TIMELINES & BUDGETS

TENTATIVE TIMELINE (1 OF 2)

- I. Contracting and Final Design Development (1-2 Months)
 1. Kick Off & Contracting: Establish project scope, objectives, and team roles

- II. Final Design Development & Engineering (3-4 Months)
 1. Feedback Integration: Revisions based on feedback, finalization of design direction
 2. Final Design: Completion of detailed CAD drawings and 3D models,
 3. Design Approval: Obtain necessary approvals from stakeholders and regulatory bodies
 4. Engineering Analysis: Structural engineer conducts load analysis and safety assessments.
 5. Preliminary Calculations: Initial structural calculations and material specifications.
 6. Detailed Engineering Drawings: Creation of detailed structural and fabrication drawings.
 7. Review and Approval: Review of engineering plans by relevant authorities and stakeholders.
 8. Final Engineering Sign-Off

**Please note that timeline is dependent on approvals, engineering analysis, site conditions, and availability.*

TENTATIVE TIMELINE (2 OF 2)

III. Fabrication (6-8 Months)

1. Material Procurement: Sourcing and inspection of all required materials.
2. Workshop Preparation: Setup of fabrication workshop and tools.
3. Cutting and Shaping: CNC cutting of steel sheets and shaping of components.
4. Welding and Assembly: Welding of components and preliminary assembly in the workshop
5. Surface Treatment: Sandblasting and application of protective coatings.
6. Quality Control: Inspection of fabricated components for quality and adherence to specifications.
7. Final Assembly: Partial assembly to ensure fit and finish, preparation for transportation.

IV. Installation (1-3 Months; *Please note that installation should begin after City Square construction is completed)

8. Transportation: Shipping of sculpture components to the installation site using flatbed trucks.
9. Staging: Setup of variable reach forklift and other necessary equipment on-site.
10. Installation: Assembly and erection of the sculpture, securing components to the foundation.
11. Final Adjustments: Fine-tuning the installation, ensuring stability and alignment.
12. Site Restoration: Removal of barriers, landscaping, and final site cleanup.
13. Project Handover: Final inspection and handover of the completed sculpture to the client and public.

**Please note that timeline is dependent on approvals, engineering analysis, site conditions, and availability.*

ESTIMATED BUDGET

Items	Quantity	Unit Cost	Line Total
Laser Cut Plastic 3 form panels	18	\$2,100.00	\$37,800.00
Laser Cut Aluminum 4'x8' sheet .25" thick	10	\$720.00	\$7,200.00
Hardware Connection and leveling hardware	1	\$3,500.00	\$3,500.00
Structural Fabrication Specialized structural fabrication necessary for engineering and installation.	1	\$15,250.00	\$15,250.00
Fabrication Module assembly	1	\$28,000.00	\$28,000.00
Shop Rental Monthly cost	4	\$2,100.00	\$8,400.00
Project Oversight Project management costs	1	\$10,200.00	\$10,200.00
Digital Design Hourly for digital design	50	\$150.00	\$7,500.00
Engineering Engineering Services	1	\$12,000.00	\$12,000.00
Shipping Transportation	1	\$9,250.00	\$9,250.00
LED Lighting LED lighting elements	1	\$3,200.00	\$3,200.00
LED Programming LED control system and programming	1	\$3,700.00	\$3,700.00

Items	Quantity	Unit Cost	Line Total
Artist Fee Artist Fee	1	\$15,400.00	\$15,400.00
Contingency Contingency for the project.	1	\$12,000.00	\$12,000.00
Installation Onsite installation, travel, room and board	1	\$11,200.00	\$11,200.00
Equipment Rental Equipment rent cost	1	\$5,500.00	\$5,500.00
Powder Coating	1	\$8,900.00	\$8,900.00
Total:			\$199,000.00
Estimate Total (USD):			\$199,000.00

**Please note that final costs and scope of artwork will be dependent on structural engineering analysis, site conditions, and material availability.*

ABOUT

Captivated by the interplay of geometry, materials, and nature, I'm passionate about crafting artworks that bridge art, technology, and the environment, while inspiring connection and contemplation.

By blending traditional craftsmanship with innovative methods, in a collaborative approach, my goal is to create visually striking pieces that positively impact our world.





PORTFOLIO

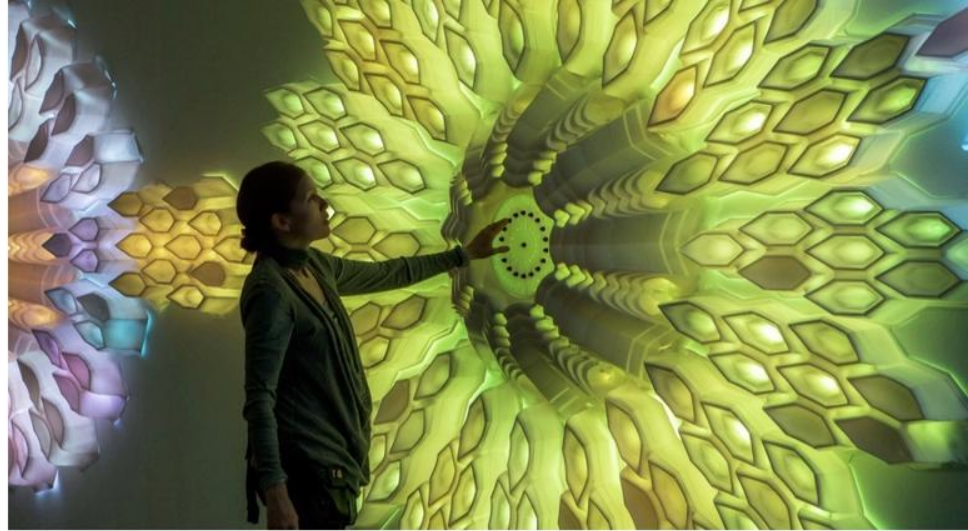

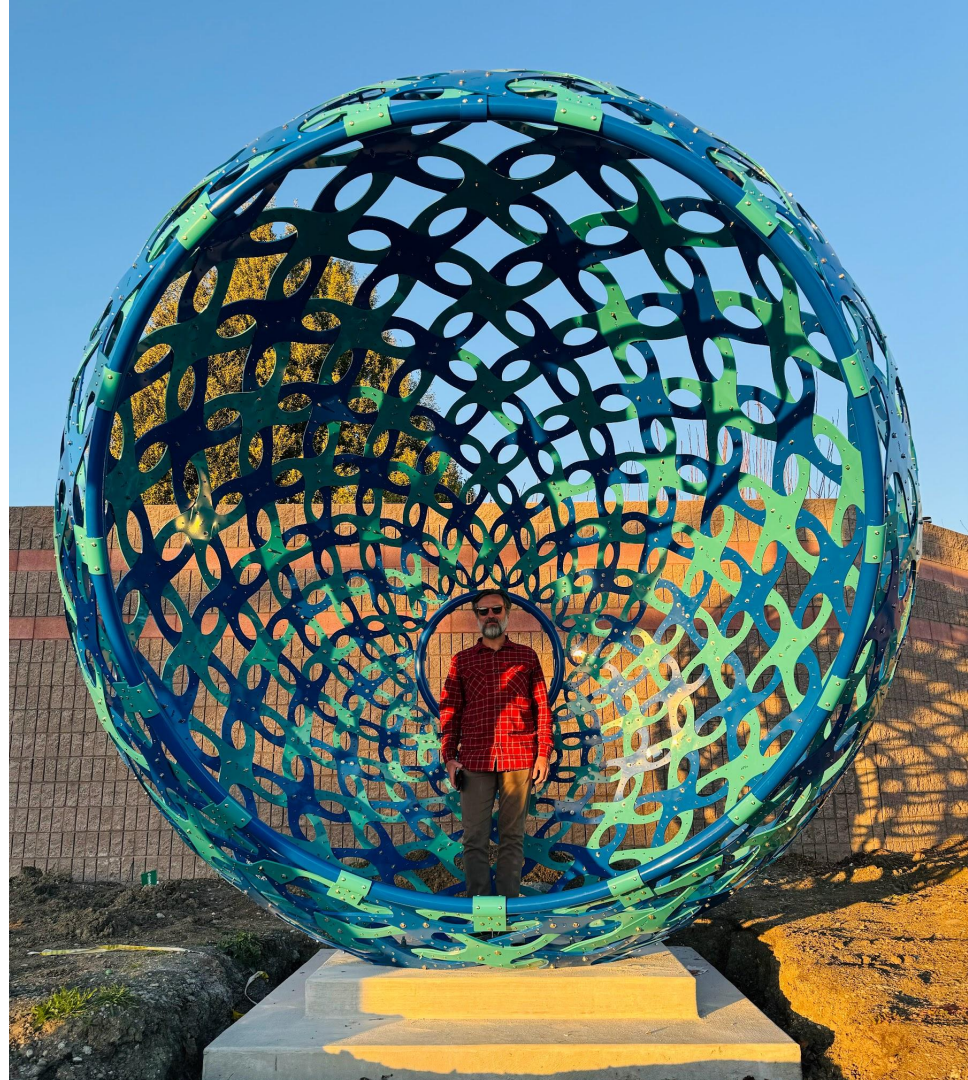

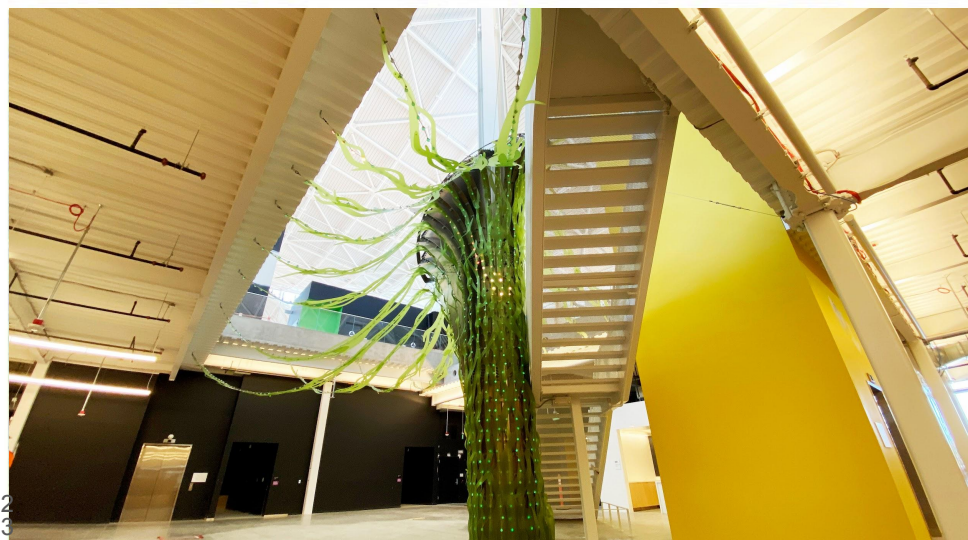





THANK YOU FOR YOUR CONSIDERATION.

JAMES PETERSON | INFO@ARTCONTRAPTIONS.COM | 310.795.7847